

**Wartung**  
**Maintenance**  
**Entretien**  
**Manutenzione**  
**Mantenimiento**

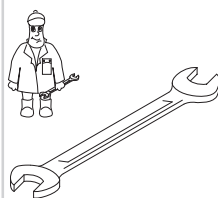

	Pos.	Menge * Quantity * Quantité * Quantità * Cantidad *	Bestell-Nr. Ident No. No. Identification No. Identificazione No. de pedido	Bezeichnung Description Designation Designazione Descripción
<b>U 4.70</b>	□	1	549000 26100	Dichtungssatz, Complete set of seals, Jeu de joints, Kit di guarnizioni, Junta Completa
	5	SATZ (KIT)	900511 00003	Schieber, Rotor Vane, Palette, Silenciador
	83	1	965416 00000	Luftentölelement, Oil separating element, Element separation huile, Cartuccia separatore olio, Elemento de desaceitar de aire

\* erforderlich / necessary / nécessaire / necessaria / necesaria

Ersatzteilliste  
Spare parts list  
Liste de pièces de rechange  
Listino pezzi di ricambio  
Lista de piezas de recambio  
Lista de peças sobresselentes  
Reserveonderdelenlijst  
Reservedelsliste  
Reservdelslista

Reservedelsliste  
Varaosaluettelo  
Wykaz czêœci zamiennych  
Seznam náhradních dílů  
Tartalékalkatrész lista  
Κατάλογος ανταλλακτικών  
Перечень запасных частей  
备用零件目录  
スペアパーツリスト

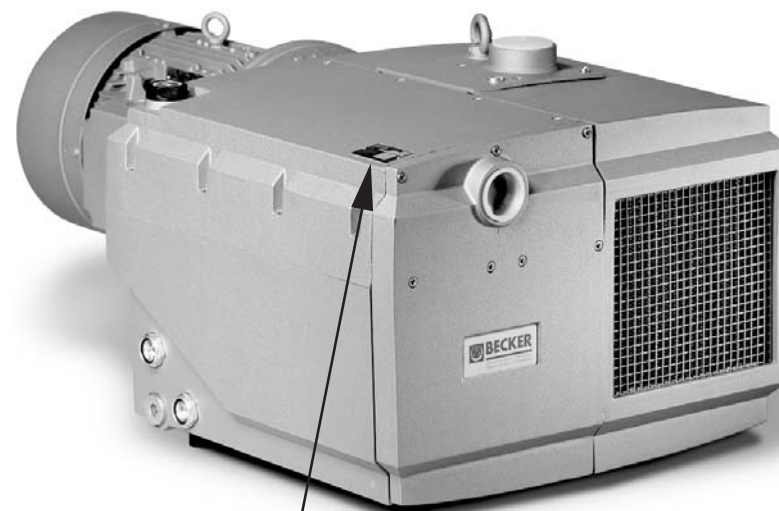

28006800000 06/2010

**Index-E**



**SERVICE**

Made in Germany

**BECKER** Baujahr/year XXXX

D-42279 Wuppertal No. E

Typ U 4.70-XX

Drehzahl / speed XXXX min<sup>-1</sup>

Leistungsbedarf motor power required XXXX kW

Saugvermögen inlet capacity XXXX m<sup>3</sup>/h

Saugdruck / vacuum XXXX mbar

Index Option

**(D) Service:**

**Tel:** +49 (0)202 697-171

**Fax:** +49 (0)202 64 44 74

**E-Mail:** [info@becker-international.com](mailto:info@becker-international.com)

 [www.becker-international.com](http://www.becker-international.com)



U 4.70

Pos.	Bestell Nr.	Beschreibung
□	549000 26100	<b>DICHTUNGSSATZ <sup>1)</sup></b>
1	000101 26100	GEHÄUSE
3	020000 26100	KOLBEN
5	900511 00003	<b>SCHIEBER (SATZ)</b>
7	917609 00000	LAGERDICHTRING
8	917501 00000	PASS-SCHEIBE
9	906622 00000	WÄLZLAGER
10	906560 00000	WELLENDICHTRING
12	912820 00000	VERSCHLUSSDECKEL
15	000800 26200	SEITENDECKEL
16	000700 26200	SEITENDECKEL
17	912871 00000	VERSCHLUSS-SCHRAUBE
18	902000 10600	GEBLÄSEKUPPLUNG
21	945320 00000	INNENSECHSKANTSCHRAUBE
22	948742 00000	PASSKERBSTIFT
24	947732 00000	PASSFEDER
28	952008 00000	SPANNHÜLSE
29	951705 00000	TELLERFEDER
30	902300 26200	VENTILATOR MIT NABE
31	947713 00000	PASSFEDER
32	901808 00000	WELLENENDSCHRAUBE
33	947507 00000	UNTERLEGSCHLEIBE
41	007800 26200	GEWINDEFLANSCH
42	533900 26200	VENTILPLATTE, KOMPLETT
44	005000 26200	SIEB
46	948219 02000	SEEGER-RING
49	928602 60000	DRUCKFEDER
52	945325 00000	INNENSECHSKANTSCHRAUBE
54	951602 00000	RINGMUTTER
55	945814 00000	GEWINDESTIFT
57	951228 02000	VERSCHLUSS-SCHRAUBE
63	509400 26200	KUGELSTÜCKSCHRAUBE
64	001702 26200	ÖLBEHÄLTERDECKEL
67	003701 26200	DECKEL
69	951005 02000	STIFTSCHRAUBE
70	948504 00000	FEDERRING
71	947104 00000	SECHSKANTMUTTER
74	305800 02000	ÜBERWURFMUTTER
76	727502 99628	ABBLASEVENTIL
83	965416 00000	<b>LUFTENTÖLELEMENT (1x) <sup>2)</sup></b>
89	921500 50000	HANDGRIFF
93	945226 00000	SECHSKANTSCHRAUBE
94	867800 99559	SCHWIMMER
97	012300 00000	ANSCHLUSSSCHRAUBE
98	912871 00000	VERSCHLUSS-SCHRAUBE
101	506000 26200	GROBABSCHIEDER KOMPLETT
104	008001 26200	FILTERBLECH
112	003703 26200	DECKEL
120	916800 10000	SCHRAUBDECKEL
130	945387 00000	INNENSECHSKANTSCHRAUBE
131	945319 00000	INNENSECHSKANTSCHRAUBE
132	945323 00000	INNENSECHSKANTSCHRAUBE
133	945319 00000	INNENSECHSKANTSCHRAUBE
134	945324 00000	INNENSECHSKANTSCHRAUBE
141	012211 26200	LEITUNG
143	012202 26200	LEITUNG
148	948401 00000	HOHLSCHRAUBE
150	012209 26200	LEITUNG
151	012205 26200	LEITUNG
152	009400 19000	KUGELSTÜCKSCHRAUBE



U 4.70

Pos.	Bestell Nr.	Beschreibung
154	012900 19000	VERSCHLUSS-SCHRAUBE
157	960202 26200	KÜHLER
158	012210 26200	LEITUNG
159	948402 00000	HOHLSCHRAUBE
181	018300 26200	ABDECKHAUBE
183	922400 60000	SCHUTZGITTER
186	568001 10700	ZWISCHENSTÜCK
187	568100 10700	STÜTZE KOMPL.
188	949408 00000	U-SCHLEIBE
190	001800 20000	WELLENABSCHLUSSSCHRAUBE
192	945318 00000	INNENSECHSKANTSCHRAUBE
193	949203 00000	ZAHNSCHLEIBE
197	741310 60000	GUMMIPUFFER
214	950700 10000	LÜSTERKLEMME
215	946304 00000	SCHRAUBE
216	943400 90000	TEMPERATURFÜHLER
233	537500 10700	VENTIL, KOMPL.
242	902101 10600	MOTORKUPPLUNGSHÄLFTE Ø28MM
245	945117 00000	SECHSKANTSCHRAUBE
246	948507 00000	FEDERRING
248	902200 10600	KUPPLUNGSRING
250	902100 26100	MOTORKUPPLUNG (US)
251	037900 26200	ZWISCHENFLANSCH (US)
254	945232 00000	SECHSKANTSCHRAUBE (US)
282	741103 99682	NIVEAUGEGER - <b>OPTIONAL</b>
283	948086 00000	DICHTUNG
301	002407 26200	ÖLBEHÄLTER
302	013301 26200	PRALLBLECH
303	945211 00000	SECHSKANTSCHRAUBE
304	951221 00100	VERSCHLUSS-SCHRAUBE
306	907309 00000	ÖLSCHAUGLAS
307	951220 00100	VERSCHLUSS-SSCHRAUBE
310	912300 00000	ANSCHLUSS-SCHRAUBE
311	912305 00000	ANSCHLUSS-SCHRAUBE
312	912306 00000	ANSCHLUSS-SCHRAUBE
314	003300 10700	DÜSE
318	952005 00000	SPANNHÜLSE

<sup>1)</sup> Dichtungssatz - 54900026100 - Pos.: 25, 26, 37, 38, 47, 58, 77, 79, 80, 121, 129, 149, 153, 160, 308  
<sup>2)</sup> erforderliche Bestellmenge / Wartung

**OPTIONAL**

<b>U 4.70 SA</b>		Sonderausführung - ohne Kühler
<b>U 4.70 SA</b>	-45	Sonderausführung - ohne Kühler
<b>U 4.70 SA/K</b>	-25	Sonderausführung - mit Öl-Wasser-Kühler
	-54	Sonderausführung - mit zusätzlicher Ölabblassbohrung
<b>U 4.70 F/K</b>	-51	Sonderausführung - mit Ölbadheizung, Niveau-Geber und Thermostat

Abweichende Positionen zum Standardgerät - siehe Anhang (Zeichnungsrückseite)



U 4.70

Pos.	Ident No.	Description
□	549000 26100	COMPLETE SET OF SEALS <sup>1)</sup>
1	000101 26100	PUMP BODY
3	020000 26100	ROTOR
5	900511 00003	ROTOR VANE IN PLASTIC (KIT)
7	917609 00000	GASKET
8	917501 00000	DISTANCE DISC
9	906622 00000	BEARING
10	906560 00000	SHAFT SEALING RING
12	912820 00000	CAP
15	000800 26200	SIDE SHIELD
16	000700 26200	SIDE SHIELD
17	912871 00000	LOCKING SCREW
18	902000 10600	COUPLING PUMP
21	945320 00000	HEX HEAD SCREW
22	948742 00000	GROOVED PIN
24	947732 00000	KEY
28	952008 00000	LOCATING PEG
29	951705 00000	SPRING DISC
30	902300 26200	FAN
31	947713 00000	KEY
32	901808 00000	SHAFT END BOLD
33	947507 00000	WASHER
41	007800 26200	FLANGE
42	533900 26200	VALVE PLATE
44	005000 26200	SIEVE
46	948219 02000	LOCKING RING
49	928602 60000	PRESSURE SPRING
52	945325 00000	SOCKET HEAD SCREW
54	951602 00000	RING UNIT
55	945814 00000	THREADED PIN
57	951228 02000	LOCKING SCREW
63	509400 26200	HOLLOW HOLDING SCREW
64	001702 26200	OIL TANK COVER
67	003701 26200	COVER
69	951005 02000	STUD
70	948504 00000	SPRING WASHER
71	947104 00000	HEX.NUT
74	305800 02000	COUPLING NUT
76	727502 99628	BLOW-OFF VALVE
83	965416 00000	OIL SEPARATING ELEMENT (1x) <sup>2)</sup>
89	921500 50000	HANDLE
93	945226 00000	HEX. HEAD SCREW
94	867800 99559	FLOAT
97	012300 00000	CONNECTING SCREW
98	912871 00000	LOCKING SCREW
101	506000 26200	COARSE SEPARATOR
104	008001 26200	SCREEN
112	003703 26200	COVER
120	916800 10000	COVER
130	945387 00000	SOCKET HEAD SCREW
131	945319 00000	SOCKET HEAD SCREW
132	945323 00000	SOCKET HEAD SCREW
133	945319 00000	SOCKET HEAD SCREW
134	945324 00000	SOCKET HEAD SCREW
141	012211 26200	PIPE
143	012202 26200	PIPE
148	948401 00000	HOLLOW SCREW
150	012209 26200	PIPE
151	012205 26200	PIPE
152	009400 19000	HOLLOW HOLDING SCREW



U 4.70

Pos.	Ident No.	Description
154	012900 19000	LOCKING SCREW
157	960202 26200	COOLER
158	012210 26200	PIPE
159	948402 00000	HOLLOW SCREW
181	018300 26200	COVERING HOOD
183	922400 60000	PROTECTIVE SHEET
186	568001 10700	INTERMEDIATE PIECE
187	568100 10700	SUPPORT PILLAR
188	949408 00000	WASHER
190	001800 20000	SCREW
192	945318 00000	SOCKET HEAD SCREW
193	949203 00000	TOOTHED SPRING WASHER
197	741310 60000	RUBBER BUFFER
214	950700 10000	CLAMP
215	946304 00000	HEX-HEAD SCREW
216	943400 90000	TEMPERATURE PROBE
233	537500 10700	VALVE
242	902101 10600	COUPLING MOTOR SIDE Ø28MM
245	945117 00000	HEX-HEAD SCREW
246	948507 00000	SPRING WASHER
248	902200 10600	GEAR RIM
250	902100 26100	COUPLING MOTOR SIDE (US)
251	037900 26200	FLANGES (US)
254	945232 00000	HEX-HEAD SCREW (US)
282	741103 99682	OIL LEVEL CONTROL - OPTIONAL
283	948086 00000	GASKET
301	002407 26200	OIL TANK
302	013301 26200	DEFLECTING PLATE
303	945211 00000	HEX-HEAD SCREW
304	951221 00100	LOCKING SCREW
306	907309 00000	OIL SIGHT GLASS
307	951220 00100	LOCKING SCREW
310	912300 00000	CONNECTING SCREW
311	912305 00000	CONNECTING SCREW
312	912306 00000	CONNECTING SCREW
314	003300 10700	NOZZLE
318	952005 00000	LOCATING PEG



<sup>1)</sup> Set of seals - 54900026100 - Pos.: 25, 26, 37, 38, 47, 58, 77, 79, 80, 121, 129, 149, 153, 160, 308  
<sup>2)</sup> necessary order quantity / maintenance

OPTIONAL

- U 4.70 SA Special design – without cooling apparatus
- U 4.70 SA -45 Special design – without cooling apparatus
- U 4.70 SA/K -25 Special design – with oil-to-water heat exchanger
- 54 Special design – with additional oil draining bore hole
- U 4.70 F/K -51 Special design – with oil bath heating, level transmitter and heat valve

Items different from standard appliance see appendix (back of drawing)



Pos.	No. Identification	Designation
□	549000 26100	<b>JEU DE JOINTS <sup>1)</sup></b>
1	000101 26100	CARCASSE
3	020000 26100	PISTON
5	900511 00003	<b>PALETTE ON PLASTIQUE (KIT)</b>
7	917609 00000	JOINT
8	917501 00000	DISQUE DE TOLERANCE
9	906622 00000	ROULEMENT
10	906560 00000	BAGUE D'ETANCHEITE
12	912820 00000	COUVERCLE
15	000800 26200	COUVERCLE
16	000700 26200	COUVERCLE
17	912871 00000	BOUCHON
18	902000 10600	ACCOUPLLEMENT POMPE
21	945320 00000	VIS HEXAGONALE INTERNE
22	948742 00000	GOUPILLE CANNELEE
24	947732 00000	CLAVETTE
28	952008 00000	DOVILLE DE ETRAGE
29	951705 00000	DISQUE DE RESSORT
30	902300 26200	VENTILATEUR
31	947713 00000	CLAVETTE
32	901808 00000	VIS BOUT D'ARBRE
33	947507 00000	RONDELLE
41	007800 26200	BRIDE
42	533900 26200	CLAPET
44	005000 26200	FILTRE
46	948219 02000	BAGUE DE SURETE
49	928602 60000	RESSORT DE PRESSION
52	945325 00000	VIS HEXAGONALE INTERNE
54	951602 00000	ECROU A ANNEAU
55	945814 00000	GOUPILLE FILETEE
57	951228 02000	BOUCHON
63	509400 26200	VIS CREUSE DE FIXATION
64	001702 26200	COUVERCLE RESERVOIR D'HUILE
67	003701 26200	COUVERCLE
69	951005 02000	PRISONNIER
70	948504 00000	ANNEAU-RESSORT
71	947104 00000	ECROU A 6PANS
74	305800 02000	ECROU
76	727502 99628	SILENCIEUX
83	965416 00000	<b>ELEMENT SEPARATION HUILE (1x) <sup>2)</sup></b>
89	921500 50000	POIGNEE
93	945226 00000	VIS HEXAGONALE
94	867800 99559	PIED CAOUTCHOVE
97	012300 00000	VIS DE RACCORD
98	912871 00000	BOUCHON
101	506000 26200	SEPARATEUR A GROS
104	008001 26200	TAMIS
112	003703 26200	COUVERCLE
120	916800 10000	COUVERCLE
130	945387 00000	VIS HEXAGONALE INTERNE
131	945319 00000	VIS HEXAGONALE INTERNE
132	945323 00000	VIS HEXAGONALE INTERNE
133	945319 00000	VIS HEXAGONALE INTERNE
134	945324 00000	VIS HEXAGONALE INTERNE
141	012211 26200	TUYAU
143	012202 26200	TUYAU
148	948401 00000	VIS CREUSE
150	012209 26200	TUYAU
151	012205 26200	TUYAU
152	009400 19000	VIS CREUSE DE FIXATION

Pos.	No. Identification	Designation
154	012900 19000	BUCHON
157	960202 26200	REFROIDISSEUR
158	012210 26200	TUYAU
159	948402 00000	VIS CREUSE
181	018300 26200	CARTER
183	922400 60000	TOLE DE PROTECTION
186	568001 10700	BRIDE
187	568100 10700	SUPPORT INTERMEDIAIRE
188	949408 00000	RONDELLE
190	001800 20000	VIS
192	945318 00000	VIS HEXAGONALE INTERNE
193	949203 00000	DENT DISQUE
197	741310 60000	AMORTISSEUR EN CAOUTCHOUC
214	950700 10000	BORNE
215	946304 00000	VIS HEXAGONALE
216	943400 90000	PALPEUR DE TEMPERATURE
233	537500 10700	SOUPAPE
242	902101 10600	ACCOUPLLEMENT MOTEUR Ø28MM
245	945117 00000	VIS HEXAGONALE
246	948507 00000	ANNEAU RESSORT
248	902200 10600	ACCOUPLLEMENT ROTEX
250	902100 26100	ACCOUPLLEMENT MOTEUR (US)
251	037900 26200	BRIDES (US)
254	945232 00000	VIS HEXAGONALE (US)
282	741103 99682	INDICATEUR DE NIVEAU - <b>EN OPTION</b>
283	948086 00000	JOINT
301	002407 26200	RESERVOIR D'HUILE
302	013301 26200	DEFLECTEUR
303	945211 00000	VIS HEXAGONALE
304	951221 00100	BOUCHON
306	907309 00000	VERRE REGARD
307	951220 00100	BOUCHON
310	912300 00000	VIS DE RACCORD
311	912305 00000	VIS DE RACCORD
312	912306 00000	VIS DE RACCORD
314	003300 10700	GICLEUR
318	952005 00000	DOUILLE DE ETRAGE

<sup>1)</sup> Jeu de joints - 54900026100 - Pos.: 25, 26, 37, 38, 47, 58, 77, 79, 80, 121, 129, 149, 153, 160, 308  
<sup>2)</sup> quantité nécessaire / entretien

**EN OPTION**

**U 4.70 SA** Fabrication spéciale – sans réfrigérant  
**U 4.70 SA -45** Fabrication spéciale – sans réfrigérant  
**U 4.70 SA/K -25** Fabrication – avec réfrigérant à l'huile et à l'eau  
**-54** Fabrication spéciale – avec trou de vidange d'huile

**U 4.70 F/K -51** Fabrication spéciale – avec chauffage du bain d'huile, capteur de niveau et thermostat

Articles divergents vis-à-vis de l'appareil standard, voir annexe (dos du dessin / du plan) 

Pos.	No. Identificazione	Designazione
□	549000 26100	<b>KIT DI GUARNIZIONI <sup>1)</sup></b>
1	000101 26100	CARCASSA
3	020000 26100	ROTORE
5	900511 00003	<b>PALETTE IN PLASTICA (KIT)</b>
7	917609 00000	GUARNIZIONE
8	917501 00000	DISCO A DISTANZA
9	906622 00000	CUSCINETTO
10	906560 00000	ANELLO DI TENUTA
12	912820 00000	COPERCHIO
15	000800 26200	COPERCHIO
16	000700 26200	COPERCHIO
17	912871 00000	VITE DI CHIUSURA
18	902000 10600	GIUNTO POMPA
21	945320 00000	VITE ESAGONALE INTERNA
22	948742 00000	SPINA INTAGLIATA
24	947732 00000	CHIAVETTA
28	952008 00000	SPINE DI RISCONTRO
29	951705 00000	DISCO A MOLLA
30	902300 26200	VENTILATORE
31	947713 00000	CHIAVETTA
32	901808 00000	VITE DI CHIUSURA ALBERO
33	947507 00000	RONDELLA
41	007800 26200	FLANGIA
42	533900 26200	SUPPORTO VALVOLA
44	005000 26200	FILTRO
46	948219 02000	ANELLO DI SICUREZZA
49	928602 60000	MOLLA DELLA PRESSIONE
52	945325 00000	VITE ESAGONALE INTERNA
54	951602 00000	GOLFARE CON FORO FILETTATO
55	945814 00000	SPINA FILETTATURA
57	951228 02000	VITE DI CHIUSURA
63	509400 26200	VITE PASSAGGIO OLIO
64	001702 26200	COPERCHIO SERBATOIO OLIO
67	003701 26200	COPERCHIO
69	951005 02000	L'ASTA A VITE
70	948504 00000	ANELLO A MOLLA
71	947104 00000	DADO ESAGONALE
74	305800 02000	DADO DI RISVOLTO
76	727502 99628	SILENZIATORE
83	965416 00000	<b>CARTUCCIA SEPARATORE OLIO (1x) <sup>2)</sup></b>
89	921500 50000	MANETTA
93	945226 00000	VITE ESAGONALE
94	867800 99559	GALLEGGIANTE
97	012300 00000	ATTACO FILETTATO
98	912871 00000	VITE DI CHIUSURA
101	506000 26200	SEPARATORE GROSSOLANO
104	008001 26200	STACCIO
112	003703 26200	COPERCHIO
120	916800 10000	COPERCHIO
130	945387 00000	VITE ESAGONALE INTERNA
131	945319 00000	VITE ESAGONALE INTERNA
132	945323 00000	VITE ESAGONALE INTERNA
133	945319 00000	VITE ESAGONALE INTERNA
134	945324 00000	VITE ESAGONALE INTERNA
141	012211 26200	CONDOTTO
143	012202 26200	CONDOTTO
148	948401 00000	VITE ESAGONALE
150	012209 26200	CONDOTTO
151	012205 26200	CONDOTTO
152	009400 19000	VITE PASSAGGIO OLIO

Pos.	No. Identificazione	Designazione
154	012900 19000	VITE DI CHIUSURA
157	960202 26200	RAFFREDDATORE
158	012210 26200	CONDOTTO
159	948402 00000	VITE ESAGONALE
181	018300 26200	CARTER
183	922400 60000	GRIGLIA DI PROTEZIONE
186	568001 10700	FLANGE
187	568100 10700	SUPPORTO
188	949408 00000	RONDELLA
190	001800 20000	VITE L 0-143
192	945318 00000	VITE ESAGONALE INTERNA
193	949203 00000	DISCO A DENTE
197	741310 60000	AMMORTIZZATORE IN GOMMA
214	950700 10000	MORSETTO
215	946304 00000	VITE ESAGONALE
216	943400 90000	TASTATORE TEMPERATURE
233	537500 10700	VALVOLA
242	902101 10600	GIUNTO MOTORE Ø28MM
245	945117 00000	VITE ESAGONALE
246	948507 00000	ANELLO A MOLLA
248	902200 10600	GIUNTO ROTEX
250	902100 26100	GIUNTO MOTORE (US)
251	037900 26200	FLANGE (US)
254	945232 00000	VITE ESAGONALE (US)
282	741103 99682	SONDA D'OLIO - <b>OPZIONALE</b>
283	948086 00000	GUARNIZIONE
301	002407 26200	SERBATOIO OLIO
302	013301 26200	DEFLETTORE
303	945211 00000	VITE ESAGONALE
304	951221 00100	VITE DI CHIUSURA
306	907309 00000	SPIA LIVELLO OLIO
307	951220 00100	VITE DI CHIUSURA
310	912300 00000	ATTACO FILETTATO
311	912305 00000	ATTACO FILETTATO
312	912306 00000	ATTACO FILETTATO
314	003300 10700	UGELLO
318	952005 00000	SPINE DI RISCONTRO

<sup>1)</sup> Serie di guarnizione - 54900026100 - Pos.: 25, 26, 37, 38, 47, 58, 77, 79, 80, 121, 129, 149, 153, 160, 308  
<sup>2)</sup> quantità di ordinazione necessari / manutenzione

**OPZIONALE**

<b>U 4.70 SA</b>		Modello speciale - senza radiatore
<b>U 4.70 SA -45</b>		Modello speciale - senza radiatore
<b>U 4.70 SA/K -25</b>		Modello speciale - con radiatore ad olio - acqua
<b>-54</b>		Modello speciale - con faro di scarico dell'olio aggiuntivo
<b>U 4.70 F/K -51</b>		Modello - con riscaldamento a bagno d'olio, indicatore di livello e termostato

Vedere allegato (retro del disegno) per le posizioni divergenti dall'apparecchio standard 

Pos.	No. De pedido	Descripción	
□	549000 26100	<b>JUEGO DE JUNTA <sup>1)</sup></b>	
1	000101 26100	CARCASEA	
3	020000 26100	ÉMBOLO	
5	900511 00003	<b>EMPUJADOR DE PLÁSTICO (KIT)</b>	
7	917609 00000	ANILLO DE COJINETE DE JUNTA	
8	917501 00000	ARANDELA DE AJUSTE	
9	906622 00000	COJINETE DE RODAMIENTO	
10	906560 00000	ANILLO DE JUNTA DE ÁRBOL	
12	912820 00000	TAPA DE CIERRE	
15	000800 26200	TAPA LATERAL	
16	000700 26200	TAPA LATERAL	
17	912871 00000	TORNILLO DE CIERRE	
18	902000 10600	ACOPLAMIENTO DE SOPLADO	
21	945320 00000	TORNILLO HEXAGONAL INTERIOR	
22	948742 00000	PASADOR ENTALLADO DE AJUSTE	
24	947732 00000	LENGÜETA DE AJUSTE	
28	952008 00000	CASQUILLO TENSOR	
29	951705 00000	ARANDELA ELÁSTICA	
30	902300 26200	ALETA DE VENTILADOR	
31	947713 00000	LENGÜETA DE AJUSTE	
32	901808 00000	TORNILLO TERMINAL DE ÁRBOL	
33	947507 00000	ARANDELA	
41	007800 26200	BRIDA ROSCADA	
42	533900 26200	PLACA DE VÁLVULA, COMPLETA O	
44	005000 26200	CRIBA	
46	948219 02000	ANILLO DE ASEGURAMIENTO	
49	928602 60000	MUELLE DE COMPRESIÓN	
52	945325 00000	TORNILLO HEXAGONAL INTERIOR	
54	951602 00000	TUERCA DE CÁNCAMO	
55	945814 00000	VARILLA ROSCADA	
57	951228 02000	TORNILLO DE CIERRE	
63	509400 26200	TORNILLO DE PIEZA ESFÉRICA	
64	001702 26200	TAPA DE RECIPIENTE DE ACEITE	
67	003701 26200	TAPA	
69	951005 02000	ESPÁRRAGO	
70	948504 00000	ARANDELA DE MUELLE	
71	947104 00000	TUERCA HEXAGONAL	
74	305800 02000	SOBRETUERCA	
76	727502 99628	VÁLVULA DE BARRIDO	
83	965416 00000	<b>ELEMENTO DE DESACEITAR DE AIRE (1x) <sup>2)</sup></b>	
89	921500 50000	EMPUÑADURA	
93	945226 00000	TORNILLO DE CABEZA HEXAGONAL	
94	867800 99559	FLOTADOR	
97	012300 00000	TORNILLO DE EMPALME	
98	912871 00000	TORNILLO DE CIERRE	
101	506000 26200	SEPARADOR DE SÓLIDOS GRUESOS COMPLETO	
104	008001 26200	CHAPA DE FILTRO	
112	003703 26200	TAPA	
120	916800 10000	TAPA ROSCADA	
130	945387 00000	TORNILLO HEXAGONAL INTERIOR	
131	945319 00000	TORNILLO HEXAGONAL INTERIOR	
132	945323 00000	TORNILLO HEXAGONAL INTERIOR	
133	945319 00000	TORNILLO HEXAGONAL INTERIOR	
134	945324 00000	TORNILLO HEXAGONAL INTERIOR	
141	012211 26200	CONDUCTO	
143	012202 26200	CONDUCTO	
148	948401 00000	TORNILLO HUECO	
150	012209 26200	CONDUCTO	
151	012205 26200	CONDUCTO	
152	009400 19000	TORNILLO DE PIEZA ESFÉRICA	

Pos.	No. De pedido	Descripción	
154	012900 19000	TORNILLO DE CIERRE	
157	960202 26200	REFRIGERADOR	
158	012210 26200	CONDUCTO	
159	948402 00000	TORNILLO HUECO	
181	018300 26200	CAPERUZA DE RECUBRIMIENTO	
183	922400 60000	REJILLA DE PROTECCIÓN	
186	568001 10700	PIEZA INTERMEDIA	
187	568100 10700	APOYO COMPLETO.	
188	949408 00000	ARANDELA	
190	001800 20000	TORNILLO TERMINAL DE ÁRBOL	
192	945318 00000	TORNILLO HEXAGONAL INTERIOR	
193	949203 00000	POLEA DENTADA	
197	741310 60000	AMORTIGUADOR DE GOMA	
214	950700 10000	TERMINAL DE CABLE	
215	946304 00000	TORNILLO DE SUJECIÓN	
216	943400 90000	SENSOR DE TEMPERATURA	
233	537500 10700	VÁLVULA COMPLETA	
242	902101 10600	MITAD DE MOTOR DE ACOPLAMIENTO, Ø28MM	
245	945117 00000	TORNILLO DE CABEZA HEXAGONAL	
246	948507 00000	ARANDELA DE MUELLE	
248	902200 10600	ANILLO DE ACOPLAMIENTO ROJO	
250	902100 26100	ACOPLAMIENTO DE MOTOR (US)	
251	037900 26200	BRIDA INTERMEDIA (US)	
254	945232 00000	TORNILLO DE CABEZA HEXAGONAL (US)	
282	741103 99682	GENERADOR DE NIVEL - <b>OPCIONAL</b>	
283	948086 00000	JUNTA	
301	002407 26200	RECIPIENTE DE ACEITE	
302	013301 26200	DEFLECTOR	
303	945211 00000	TORNILLO DE CABEZA HEXAGONAL	
304	951221 00100	TORNILLO DE CIERRE	
306	907309 00000	CRISTAL MIRILLA DE ACEITE	
307	951220 00100	TORNILLO DE CIERRE	
310	912300 00000	TORNILLO DE EMPALME	
311	912305 00000	TORNILLO DE EMPALME	
312	912306 00000	TORNILLO DE EMPALME	
314	003300 10700	TOBERA	
318	952005 00000	CASQUILLO TENSOR	

<sup>1)</sup> Junta completa - 54900026100 - Pos.: 25, 26, 37, 38, 47, 58, 77, 79, 80, 121, 129, 149, 153, 160, 308

<sup>2)</sup> cantidad necesario / mantenimiento

**OPCIONAL**

**U 4.70 SA** Versión especial – sin refrigerador  
**U 4.70 SA -45** Versión especial – sin refrigerador  
**U 4.70 SA/K -25** Versión especial – con refrigerador aceite-agua  
**-54** Versión especial – con perforación de salida de aceite adicional

**U 4.70 F/K -51** Versión – con calefacción de baño de aceite, codificador de nivel y termostato

Para posiciones que derivan del aparato standard véase apéndice (lado trasero del plano)

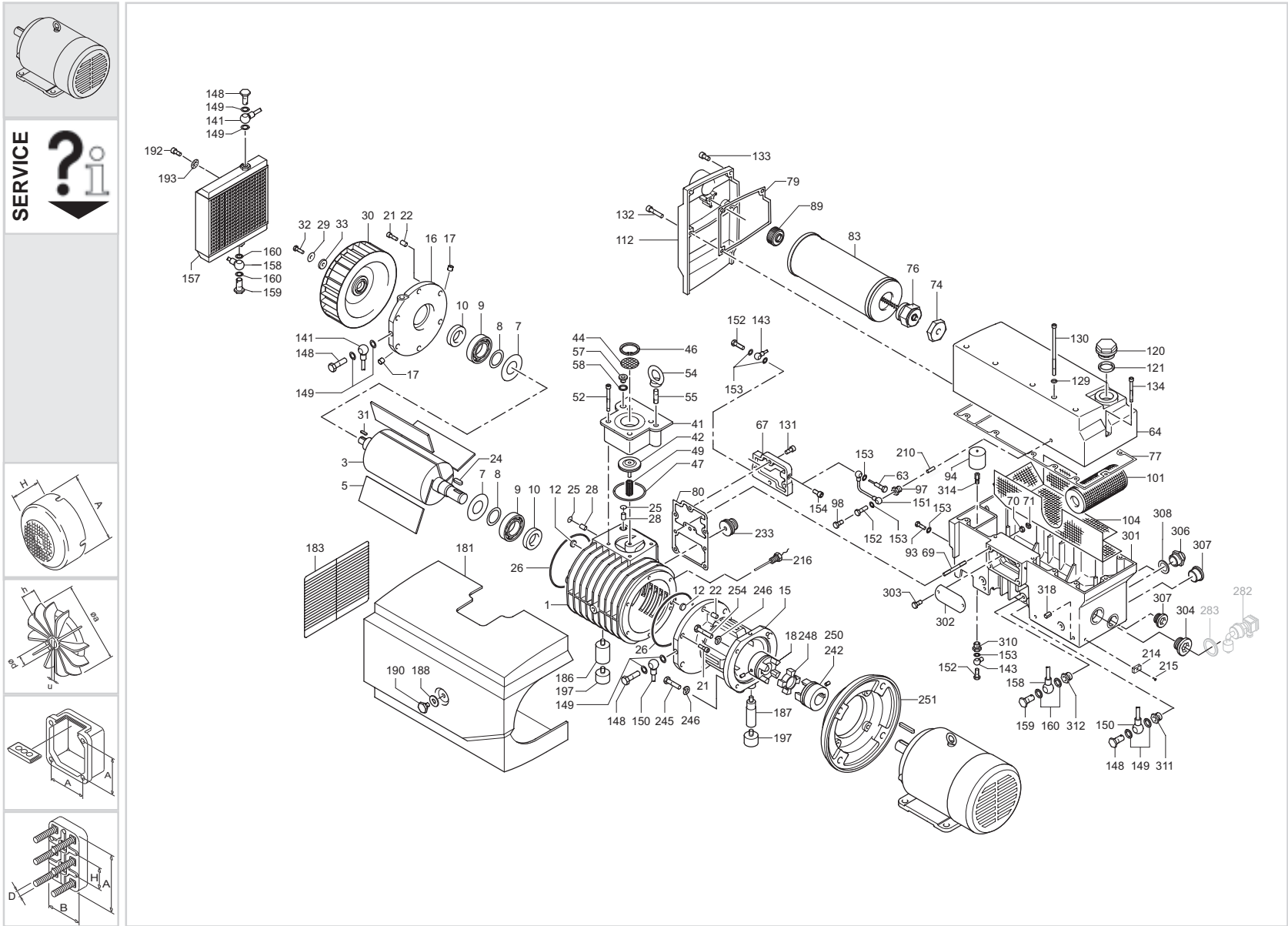



standard

U 4.70 F/K

U 4.70 SA/K

 optional  
 en option  
 optionale  
 opcional

optional en option optionale opcional 	Variante(n) Modifications Variantes	Pos <sup>2)</sup>	Bestell Nr. / Ident No. / No. Identification / No. Identificazione / No. De pedido		Beschreibung / Description / Designation / Designazione / Desripcion	
						
<b>U 4.70 SA/XX</b>  <b>U 4.70 F/XX</b>	U 4.70 SA U 4.70 SA - 45	141 144 146 157 158 159 160 192	012203 26200 912305 00000	012211-26200  960202-26200 012210-26200 948402-00000 948030-00000 945318-00000	LEITUNG / PIPE / TUYAU / CONDOTTO / CONDUCTO LEITUNG / PIPE / TUYAU / CONDOTTO / CONDUCTO <b>SA-45</b> - ANSCHLUSS-SCHRAUBE / CONNECTING SCREW / VIS DE RACCORD / ATTACO FILETTATO / TORNILLO DE EMPALME KUEHLER / COOLER / REFRROIDISSEUR / RAFFREDDATORE / REFRIGERADOR LEITUNG / PIPE / TUYAU / CONDOTTO / CONDUCTO HOHLSCHRAUBE / HOLLOW SCREW / VIS CREUSE / VITE ESAGONALE / TORNILLO HUECO KUPFERRING / SEALING RING / JOINT / ANNELLO / ANILLO DE COBRE INNENSECHSKANTSCHRAUBE / SOCKET HEAD SCREW / VIS HEXAGONALE INTERNE / VITE ESAGONALE INTERNA / TORNILLO HEXAGONAL INTERIOR ZAHNSCHEIBE / TOOTHED LOCK WASHER / RONDELLE À DENTS / RONDELLA DENTATA / ARANDELA DENTADA <b>SA-45</b> - AUSLASSHAHN / STOP COCK / ROBINET D'ARRÊT / RUBINETTO DI ARRESTO / LLAVE DE INTERRUCCIÓN	
	U 4.70 SA/K - 25	29 30 31 32 33 98 141 150 155 157 158 181 192	951705-00000 902300-26200 947713-00000 901808-00000 947507-00000  912871 00000 012214 26200 012213 26200 012209-26200  960204 26200 012210-26200 018300 26200 945318-00000	951705-00000 902300-26200 947713-00000 901808-00000 947507-00000  012211-26200 012209-26200  960202-26200 012210-26200 018300-26200 945318-00000	FEDERSCHLEIBE / LOCKING WASHER / RONDELLE À RESSORT / RONDELLA A MOLLA / ARANDELA DE RESORTE VENTILATOR / FAN / VENTILATEUR / VENTILATORE / VENTILADOR PASSFEDER / KEY / CLAVETTE / CHIAVETTA / CHAVETA WELLENENDSCHRAUBE / SCREW / VIS / VITE / TORNILLO U-SCHLEIBE / WASHER / RONDELLE / RONDELLA / ARANDELA VERSCHLUSSSCHRAUBE / LOCKING SCREW / BOUCHON / VITE DI CHIUSURA / TORNILLO DE CIERRE LEITUNG / PIPE / TUYAU / CONDOTTO / CONDUCTO LEITUNG / PIPE / TUYAU / CONDOTTO / CONDUCTO HOHLSCHRAUBE / HOLLOW SCREW / VIS CREUSE / VITE ESAGONALE / TORNILLO HUECO KUEHLER / COOLER / REFRROIDISSEUR / RAFFREDDATORE / REFRIGERADOR LEITUNG / PIPE / TUYAU / CONDOTTO / CONDUCTO HAUBE / PROTECTING HOOD / CARTER PROTECTEUR / CARTER DI PROTEZIONE / SOMBRERETE INNENSECHSKANTSCHRAUBE / SOCKET HEAD SCREW / VIS HEXAGONALE INTERNE / VITE ESAGONALE INTERNA / TORNILLO HEXAGONAL INTERIOR ZAHNSCHLEIBE / TOOTHED LOCK WASHER / RONDELLE À DENTS / RONDELLA DENTATA / ARANDELA DENTADA GUMMIPUFFER / RUBBER BUFFER / AMORTISSEUR EN CAOUTCHOUC / AMMORTIZZATORE IN GOMMA / AMORTIGUADOR DE GOMA GEWINDESTIFT / THREADED PIN / GOUPILLE FILETEE / SPINA FILETTATURA / VARILLA ROSCADA L-VERSCHRAUBUNG / L-PIECE / L-PIECE / PEZZO A L / ATORNILLADURA	
	U 4.70 F/K - 51	210 301  305 309 315 316 317 319 321	003301 30000 002409 26200  948011 00000 912314 00000 960203 26200 943400 70000 741103 99682 948070 00000 948086 00000	002407-26200	DÜSE / NOZZLE / GICLEUR / UGELLO / TOBERA ÖLABSCHEIDERGEHÄUSE / HOUSING FOR OIL SEPARATION / CARCASSE POUR SEPARATION D'HUILLE / CARCASSA SEPARATORE OLIO / CARCASA SEPARADORA DE ACEITE KUPFERRING / SEALING RING / JOINT / ANNELLO / ANILLO DE COBRE ANSCHLUSSSCHRAUBE / CONNECTION SCREW / VIS DE RACCORDEMENT / VITE DI RACCORDO / TORNILLO DE EMPALME ROHRHEIZKÖRPER / PIPE HEATER / CORPS DE CHAUFFE / SCALDIGLIA / CALEFACTOR TUBULAR TEMPERATUR-WÄCHTER / THERMOSTAT / THERMOSTAT / INTERRUTTORE TERMICO / TERMOSTATO NIVEAUGEBER / LEVEL TRANSMITTER / CAPTEUR DE NIVEAU / INDICATORE DI LIVELLO / CODIFICADOR DE NIVEL DICHTUNG / GASKET / JOINT / GUARNIZIONI / ANILLO DICHTUNG / GASKET / JOINT / GUARNIZIONI / ANILLO	
	U 4.70 SA/K - 54	301  307	002408 26200  951220 00100	002407-26200	ÖLABSCHEIDERGEHÄUSE / HOUSING FOR OIL SEPARATION / CARCASSE POUR SEPARATION D'HUILLE / CARCASSA SEPARATORE OLIO / CARCASA SEPARADORA DE ACEITE VERSCHLUSSSCHRAUBE / LOCKING SCREW / BOUCHON / VITE DI CHIUSURA / TORNILLO DE CIERRE	

<sup>2)</sup> variantenabhängige Bauteile / variant-dependent components / composants variante-dependantes / componenti variante-dispendenti / componentes variante-dependientes